

SIEMENS

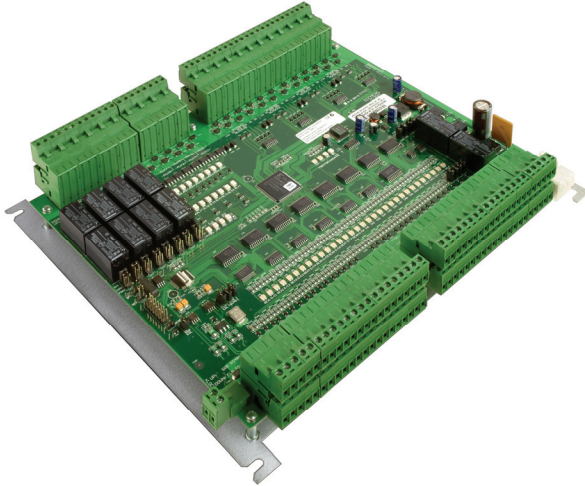

SiPass integrated ADE5300 Eight Reader Interface

Installation Manual

Siemens AB

Security Product

Liefermöglichkeiten und technische Änderungen vorbehalten.
Data and design subject to change without notice. / Supply subject to availability.
© 2011 Copyright by Siemens AB

Wir behalten uns alle Rechte an diesem Dokument und an dem in ihm dargestellten Gegenstand vor. Der Empfänger erkennt diese Rechte an und wird dieses Dokument nicht ohne unsere vorgängige schriftliche Ermächtigung ganz oder teilweise Dritten zugänglich machen oder außerhalb des Zweckes verwenden, zu dem es ihm übergeben worden ist.

We reserve all rights in this document and in the subject thereof. By acceptance of the document the recipient acknowledges these rights and undertakes not to publish the document nor the subject thereof in full or in part, nor to make them available to any third party without our prior express written authorization, nor to use it for any purpose other than for which it was delivered to him.

Contents

1	Product description	5
2	Safety	5
3	Technical specifications	6
3.1	Dimensions	7
4	Ordering data.....	7
5	Scope of delivery	7
6	Installation	8
7	Connections and LEDs.....	9
7.1	Connections	9
7.2	Port locations	10
7.3	Reader wiring.....	10
7.4	Wiring of monitored input	10
7.5	FOR inputs	11
7.6	Jumper settings.....	12
7.7	LEDs	13
8	Cable specifications	14
9	Programming and firmware download	14
10	Disposal	15
10.1	Record of proper waste management.....	15

1 Product description

The ADE5300 is a Reader Interface Module (RIM) used as part of an integrated Siemens access control and security solution. It provides an interface between an Advanced Central Controller (AC5100) and up to eight readers/doors.

2 Safety

**PLEASE NOTE**

We decline any liability for material damage or personal injury caused by improper use or non-observance of these safety instructions. In such case any guarantee expires.

**PLEASE NOTE**

Connection, commissioning and maintenance must only be carried out by suitably qualified personnel.
Correct and safe operation of this device depends on proper transport, storage, installation and connection, as well as careful operation and maintenance.

**DANGER**

Work on electrical systems should only be performed by trained personnel under the supervision of a certified electrician in accordance with the appropriate regulations.

3 Technical specifications

Electrical	
Power (input)	12 V DC, -15 to +10% or 24 V DC, -15 to +10%
Consumption	max. 2 A @ 12 V, max. 1.5 A @ 24 V (max Consumption: All Relays are driven and all open collector outputs are supplying the max. current of 100 mA. The reader power supplies are not included!)
Communications FLN	RS-485 two wire, half-duplex
Reader Interfaces	8 x Wiegand Reader Interfaces, or 1 x Siemens RS-485 Reader Interface for connecting up to eight Readers
Lock output	8 x Relay driven 2 A @ 30 V DC
Auxiliary output	8 x Open-Collector 100 mA @ 9.7 – 12 V DC
Inputs (internally supplied)	8 x Door contact 8 x Request-to-Exit 16 x Auxiliary All inputs unsupervised or supervised
Supervision	Requires connection of a supervision circuit.
Fire Override (FOR) input	2 x Normal or Enhanced Modes: <ul style="list-style-type: none"> ● Normal Mode requires an Input Voltage of 12 V DC ● Enhanced mode requires the connection of 22 kOhm resistor circuits. Cable must be shielded and total cable run resistance must not exceed 100 Ohms.
Fire Override (FOR) output	2 x Relay 2 A @ 30 V DC
Local input	1 x passive device connection (unsupervised)
Local output	1 x open-collector 100 mA @ 9.7– 12 V DC
Reader Power supplies	8 x 400 mA @ 9.7 – 12 V DC 1 x 1.5 A @ 9.7 – 12 V DC
Dimensions	
with baseplate (W x H x D)	250 x 287 x 50 mm (9.84 x 11.30 x 1.97")
without baseplate (W x H x D)	216 x 267 x 37 mm (8.50 x 10.51 x 1.46")
Environmental	
Operating temperature	0 – 50 °C (32 – 122 °F)
Storage temperature	0 – 60 °C (32 – 140 °F)
Humidity	10 – 90% (non-condensing)
Standards and Guidelines	
European Directives “Directive of Electromagnetic Compatibility”	Emitted interference: EN 61000-6-3: 2001 EN 55022 +A1 +A2 KI. B: 2003 Interference resistance: EN 50130-4 +A2: 2003
C-Tick	Standard for Australia and New Zealand (equivalent to EN 55022 of the European Directive).
UL-Directives	UL 294 Access control units Details can be found under: http://database.ul.com/cgi-bin/XYV/template/LISEXT/1FRAME/gfilenbr.html with UL File Number: BP9490

3.1 Dimensions

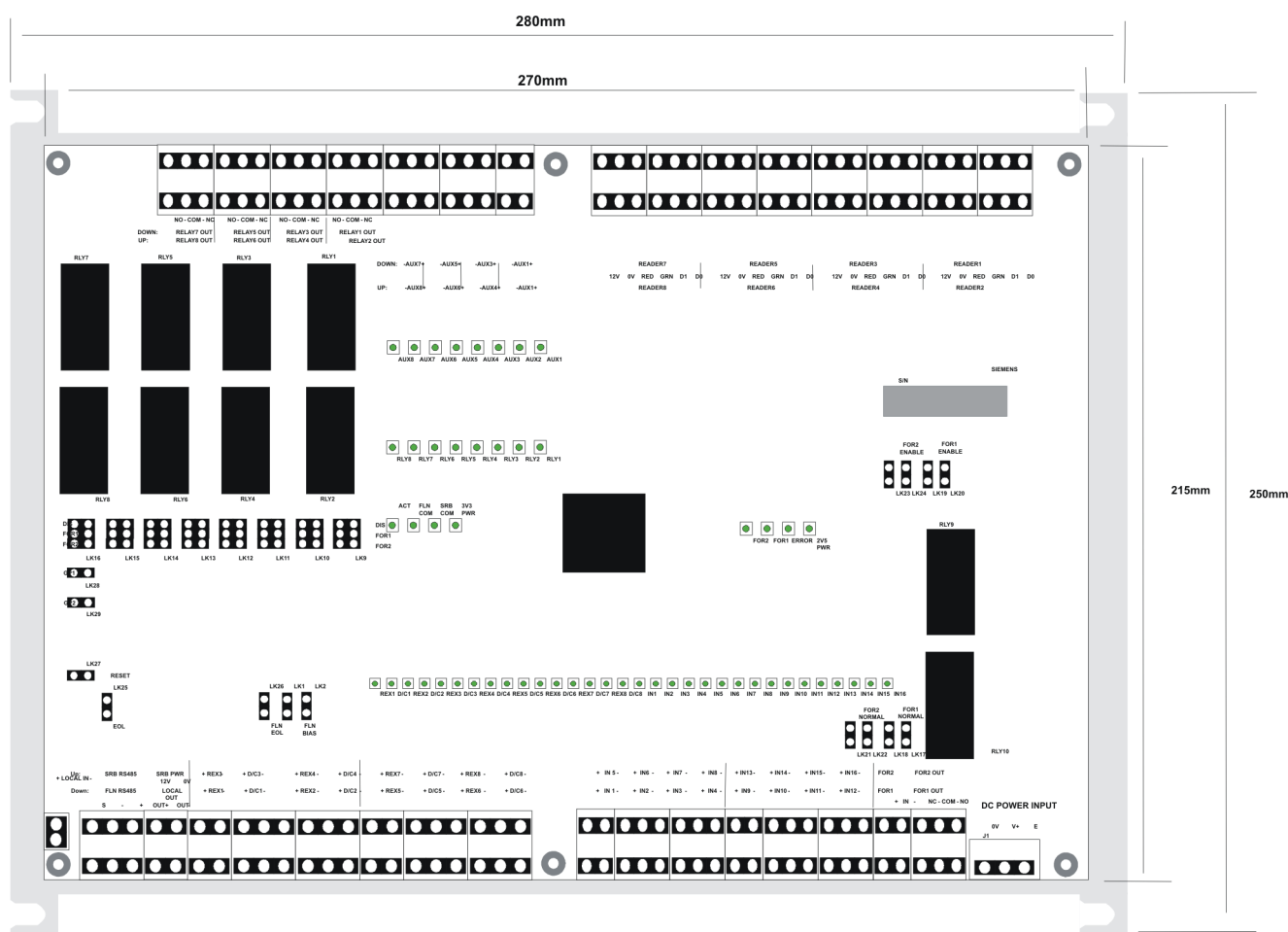

Fig. 1 Dimensions (including base plate)

- Width: 250 mm (9.84")
- Height: 287 mm (11.30")
- Depth: 50 mm (1.97")

4 Ordering data

Type	Part no.	Designation	Weight
ADE5300	S24246-A2500-A1	Eight Reader Interface	1.3 kg

5 Scope of delivery

- 1 x ADE5300 mounted on base plate
- 1 x accessory bag (resistors for monitored inputs)
- 1 x installation manual English
- 1 x installation manual German

6 Installation

Required tools & material

- Medium-duty drill and associated drill-bits
- 4 mounting screws or standoffs (approx. 4 mm)
- Flat-blade terminal screwdriver
- Wire cutters
- Cable strippers

Expected installation time

30 minutes

Mounting instructions

1. Remove the ADE5300 from its carton and discard the packaging material.
2. Place the ADE5300 (base plate) against the surface to which it is to be affixed and mark the location of the mounting holes.
We recommend to mount the ADE5300 within a cabinet. Align the ADE5300 base plate with the holes located on the cabinet backplane and proceed to step 3.
It is recommended that you affix the ADE5300 at all four of the mounting locations provided.



Warning

Do not apply power to the ADE5300 or associated components at this stage.

3. Select the appropriate drill bit according to the mounting surface / hole size and drill the holes in the locations marked (if required).
4. Fasten the ADE5300 (base-plate) to the surface using the correct type of screws or standoffs for the surface.
5. Connect the cabling to the ADE5300 PCB. See section 7.1: Connections.
6. Apply power to the ADE5300 and test its operation.
This step may require installation and programming of the access control host software and download of the firmware instruction set.
Alternatively, the firmware and configuration may be carried out using the FLN Field Service Tool.

7 Connections and LEDs

7.1 Connections



It is recommended that you wear a grounding strap while carrying out this procedure.

1. Connect each **Wiegand reader** to the appropriate **READER** port of the ADE5300, or connect the **SIEMENS RS485** readers to the **SRB RS485** port. Up to 8 Siemens RS485 readers can be daisy chained (from one reader to another) on the same connection.



Each reader must be wired correctly. For more information, see Section 7.3: Reader wiring. The total resistance for each reader cable must not exceed 16.8 Ohms.

2. Connect the **Request to Exit (REX) switch** (e.g. door opener button) to the appropriate **REX** input on the ADE5300.
3. Connect each **door contact** (door monitor) to the appropriate **D/C** input port on the ADE5300. For example, connect the contact for Door 1 to "D/C1".
4. Connect auxiliary inputs (if required) to the **Input IN1** to **IN16** on the PCB.



Listed end-of-line resistors must be connected to the wiring for each input device if they are to be supervised. For more information, see Section 7.4: Wiring of monitored input.

Please note (this applies to all inputs): The total cable run resistance must not exceed 100 Ohms.

5. Connect any auxiliary output devices to the **AUX OUT ports** (open collector) on the ADE5300.
6. Connect each **door opener** to the appropriate **RELAY OUT** port on the ADE5300. Access doors can only be connected to output relays that are controlled by readers.
7. For example, connect the **lock** for door 1 to the "RELAY1 OUT" connection on the ADE5300. Ensure that the power supply used to drive the lock is sufficiently rated.
8. Connect the wiring from the **fire or emergency override system** to the **FOR IN** ports, if required. Ensure the correct **FOR** link settings are applied.
9. Connect the next device in the Fire Override sequence to the **FOR OUT ports** (only if required).
10. Connect the **FLN wires** (from the AC5100) to the **FLN RS485** port.
11. Connect the active (+ve) and neutral (-ve) wires from the **Power Supply Unit (PSU)** to the **DC POWER INPUT** port. Ensure the polarity of the connection is made correctly.
12. Check all **jumpers**. For more information, see Section 7.6: Jumper settings.
13. Check all connections thoroughly, including the polarity of each connection. Once you have verified all connections power can be applied to the ADE5300.

7.2 Port locations

Port name	Description
DC POWER INPUT	DC power input (12 V DC or 24 V DC)
FLN RS485	RS-485 bus for AC5100, FLN bus
READER 1-8	Card reader: communication, power, LED's
RELAY 1-8 OUT	Door lock / strike relay driven output
D/C 1-8	Door contact
REX 1-8	Request to exit input (REX)
IN 1-16	Inputs
AUX 1-8	Open-collector 12 V DC outputs
FOR* 1-2 IN	FOR inputs (e.g. fire alarm button)
FOR* 1-2 OUT	FOR outputs
LOCAL IN	Tamper input for local tamper detection
LOCAL OUT	Alarm output (e. g. siren, strobe light)
SRB RS485	Connection for a serial card reader
SRB PWR	Power output for serial card readers

7.3 Reader wiring

Wiegand reader wiring

Reader Type	D0	D1	GRN	RED	0 V	12 V
Wiegand	D0	D1	GRN	RED	0 V	12 V

RS-485 reader wiring

Reader Type	12V	0 V	TX/-	RX/+	RTS	CTS	CTS
RS-485	8V/12V	0V/GND	-	+	not available	not available	shield

7.4 Wiring of monitored input

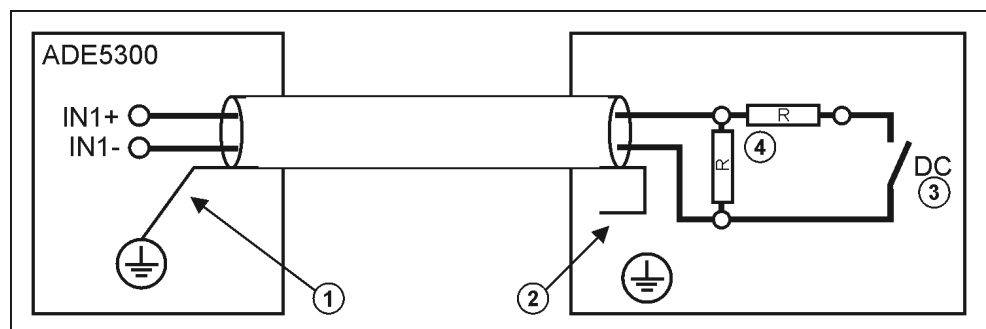

- 1 Connect the shielding to the housing earth.
- 2 Insulate the shielding at the input (e.g. door contact), do not connect it.
- 3 DC: door contact
- 4 R: terminating resistors each 22 kOhm

Fig. 2 Wiring of monitored input

* FOR: Fire Override

7.5 FOR inputs

ADE5300	External device	Port	Remark
FOR* input (normal mode)	Fire alarm system (+ UB)		Fire alarm system output: Fire alarm system OK → +12 V In case of fire alarm or malfunction → 0 V
FOR* input (normal mode)	Fire alarm system (relay contact)		Fire alarm system output: Fire alarm system OK → contact between NO and COM closed In case of fire alarm or malfunction → contact between NO and COM open
FOR* input (enhanced mode)	Fire alarm system (relay contact)		Fire alarm system output: Fire alarm system OK → contact between NO and COM closed In case of fire alarm or malfunction → contact between NO and COM open

The following diagram provides an example for wiring a door lock in a fail-safe mode for fire override operation.

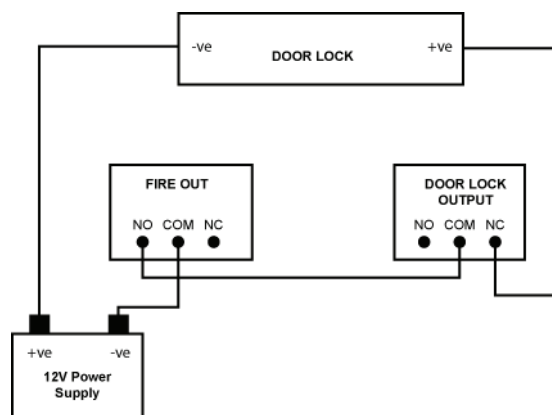

* FOR: Fire Override

7.6 Jumper settings

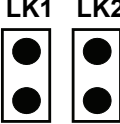
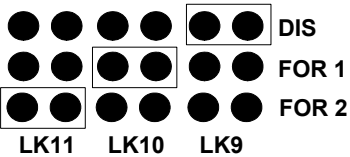
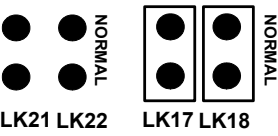
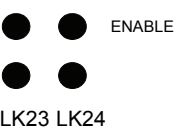
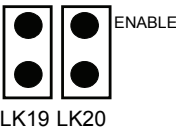
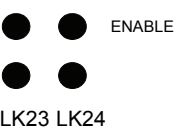
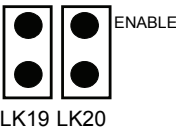
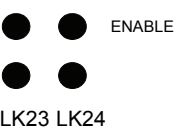
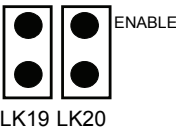
Jumper	Description	Value						
LK1 + LK2	<p>BIAS</p> <p>These links enable the RS-485 bus biasing resistors. The resistors create a voltage divider to force the voltage to be less than the threshold of the receiver. This prevents invalid data bits that are picked up from the noise on the cable from being transmitted.</p>	<p>Jumper placed across LK1 and LK2: → RS485-FLN biasing resistors enabled.</p> 						
LK9 – LK16	<p>FOR OUTPUT CONTROL</p> <p>These links control the Fire Over-ride activation for each individual relay output 1-8.</p> <p>Depending on where you place the link, the relay output behaviour will be modified by FOR 1 input, FOR 2 input, or FOR will be disabled for that relay.</p>	 <p>Relay output RELAY1 OUT (LK9) is set to <i>FOR disabled</i>, Relay output RELAY2 OUT (LK10) is set to <i>FOR 1</i>, Relay output RELAY3 OUT (LK11) is set to <i>FOR 2</i>.</p>						
LK17 and LK18 + LK21 and LK22	<p>FOR MODE</p> <p>Configuration of the Fire Override mode:</p> <ul style="list-style-type: none"> – Enhanced FOR mode (monitored) – Normal FOR mode (floating). 	 <p>Jumpers placed over both links (e.g. FOR1): → Input set to Normal FOR mode. Both jumpers removed (e.g. FOR2): → Input set to Enhanced FOR mode.</p>						
LK19 and LK20 + LK23 and LK24	<p>FOR AKTIVATION</p> <ul style="list-style-type: none"> – FOR enabled → Activation of the FOR input will cause the appropriate output relays to pick up or drop out depending on where the links LK9 – LK16 are placed. – FOR disabled → The input will have no effect on the relays. 	<table border="1"> <thead> <tr> <th>FOR 2</th> <th>FOR 1</th> </tr> </thead> <tbody> <tr> <td>  </td> <td>  </td> </tr> <tr> <td>FOR disabled</td> <td>FOR enabled</td> </tr> </tbody> </table>	FOR 2	FOR 1			FOR disabled	FOR enabled
FOR 2	FOR 1							
								
FOR disabled	FOR enabled							
LK25	<p>EOL TERMINATION (Serial Reader Interface)</p> <p>This link allows the Serial Card Interface communications channel to be terminated in noisy comms lines. Note: It is only to be fitted on the first unit or the last unit on the bus.</p>							
LK26	<p>EOL TERMINATION (FLN System Bus)</p> <p>This link allows the RS485 bus communication channel to be terminated in lengthy comms lines – more than 100 m at 115 kb/s. Note: Only units that are located at the ends of bus lines should have Link 26 set to on.</p>							
LK27	<p>RESET (Restart)</p> <p>Reset the ADE5300 retaining the unit's firmware:</p> <ul style="list-style-type: none"> – Interrupt the power supply to the unit for 1 sec or – Close link 27, wait for the activity LED to switch off, then remove LK2. 							
LK28	<p>GP1 RESET MODE</p> <p>Reset the firmware:</p> <ul style="list-style-type: none"> – Close LK28 – Close link 27, wait for the activity LED to switch off, then remove LK2. – Remove LK28 before loading the new firmware 							
LK29	No Link – General purpose link included for future enhancement							

7.7 LEDs

LED	Description
ACT	ACTIVITY LED 1. LED blinking quickly: Firmware needs to be downloaded 2. LED blinking slowly (approx. once per sec): Firmware has been downloaded
FLN COM	The LED flashes when the ADE5300 is sending data to the AC5100.
SRB COM	The LED flashes when the ADE5300 is receiving data from an RS485 card reader.
RLY (1-8)	The Output relays status is displayed as activated with green LEDs.
IN1 – IN32	Status of inputs
REX1 – REX8	LED red: Alarm (Fire Override at FOR input)
DC1 – DC8	LED green: Normal
FOR1 IN - FOR2 IN	LED orange: Tampering LED off (only FOR1/2 IN): FOR disabled
ERROR	LED active: corrupt or non fully programmable EPROM
PWR	LED active: power is applied to the PCB

8 Cable specifications



The table provides a guideline for selecting an appropriate cable type only.
Other cable types are also compatible with the system and can be used to achieve the same results.

Communication Type	Recommended Cable Specifications								
	Cores	Pairs	AWG	Cores	J-Y(St)Y Diameter (mm)	Wire Type	Insulation	Shield	Jacket
RS-485	4	2	28	7 x 36	0.6	Tinned Copper	Foam Polyethylene	Aluminium foil - Polyester tape / braided shield	PVC
	6	3							
	8	4							
RS-232	4	2	24	7 x 32	0.6	Tinned Copper	Foam Polyethylene	Aluminium foil - Polyester tape / no braid	PVC
	6	3							
	8	4							
RS-422	4	2	24	7 x 32	0.6	Tinned Copper	Foam Polyethylene	Aluminium foil - Polyester tape / no braid	PVC
	6	3							
	8	4							
RJ-45	8	4	24	Solid	0.6	Bare Copper	Polyethylene	Unshielded	PVC
	8	4	24	7 x 32	0.6	Tinned Copper			
RJ-12	8	4	24	Solid	0.6	Bare Copper	Polyethylene	Aluminium foil - Polyester tape / no braid	PVC
	8	4	24	7 x 32	0.6	Tinned Copper			
Power (12/24 V DC)	2	1	18	19 x 30	1.0	Tinned Copper	Foam Polyethylene	Unshielded	PVC

9 Programming and firmware download

The ADE5300 is programmed using SiPass software, via the AC5100, or using the „FLN Configurator“ application. Please refer to the appropriate User's Manual for more information.

10 Disposal



All electrical and electronic products should be disposed of separately from the municipal waste stream via designated collection facilities appointed by the government or the local authorities.

This crossed-out wheeled bin symbol on the product means the product is covered by the European Directive 2002/96/EC.

The correct disposal and separate collection of your old appliance will help prevent potential negative consequences for the environment and human health.

It is a precondition for reuse and recycling of used electrical and electronic equipment.

For more detailed information about disposal of your old appliance, please contact your city office, waste disposal service or the shop where you purchased the product.

10.1 Record of proper waste management

A record of proper waste management is not required.

Issued by
Siemens AB
Infrastructure & Cities
Security Products
International Headquarters
Englundavägen 7
SE-171 24 Solna
Tel. +46 8 629 0300

www.siemens.com/securityproducts

© 2011 Copyright by Siemens AB

Data and design subject to change without notice.
Supply subject to availability.

Document No. **A24205-A335-B275**

Edition 06.12.2011